

501 Trietex



KLEUREN / COULEURS



-10
Wit
Blanc

EIGENSCHAPPEN / CARACTÉRISTIQUES

- Glijkanaal 6 mm (breedspoor)
- Profiellengte 700 cm
- Profielgewicht 589 g/m
- Niet verbuigbaar
- Geschikt voor:
 - Zware toepassingen
 - Schuin geplaatste toepassingen
- Canal de 6 mm (profil large)
- Longueur du profil 700 cm
- Poids du profil 589 g/m
- Non pliable
- Convient à:
 - Applications très lourds
 - Applications inclinés

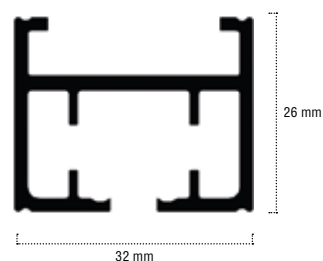

AFMETINGEN / DIMENSIONS

